

女子学校对抗戦

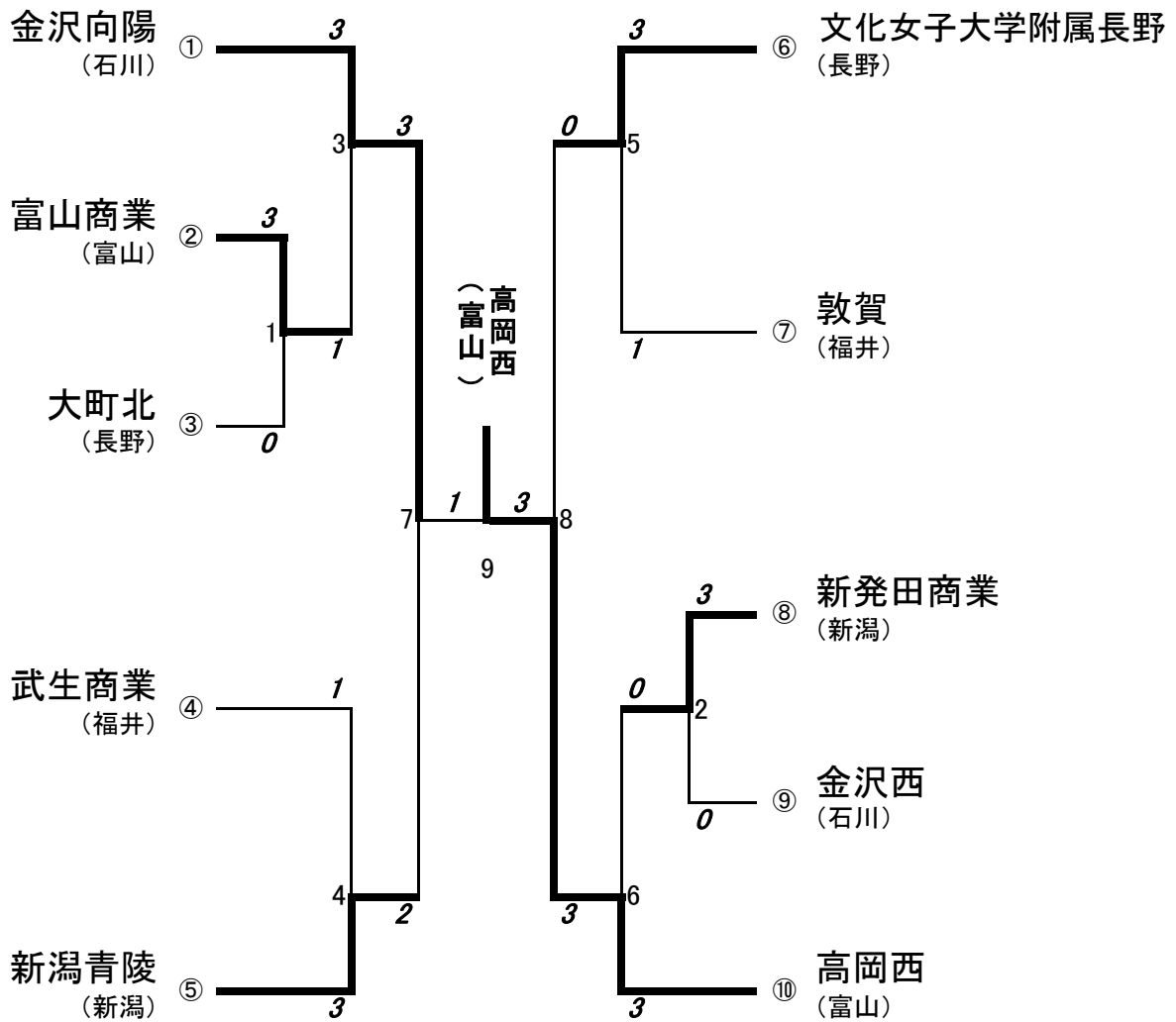

第2代表決定戦

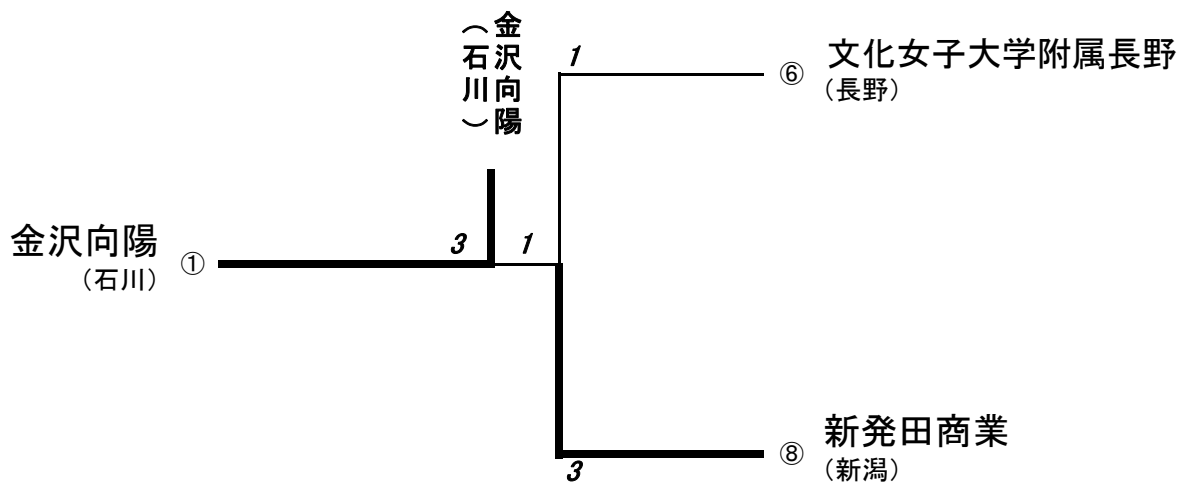

男子個人対抗戦 (BD)

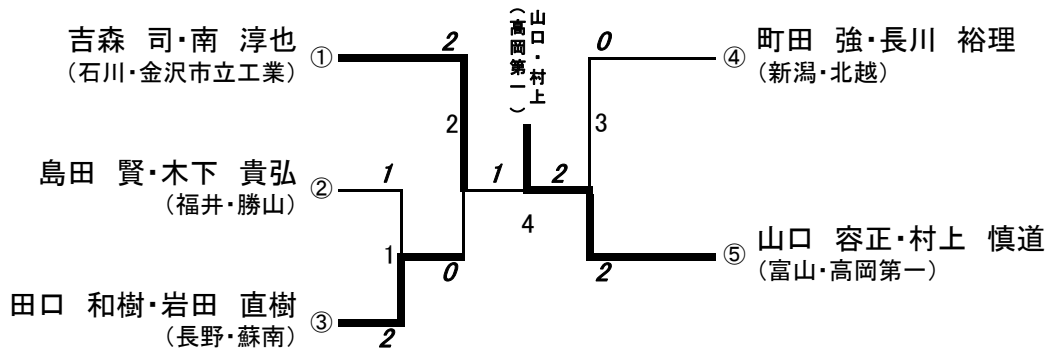

男子第2代表決定戦

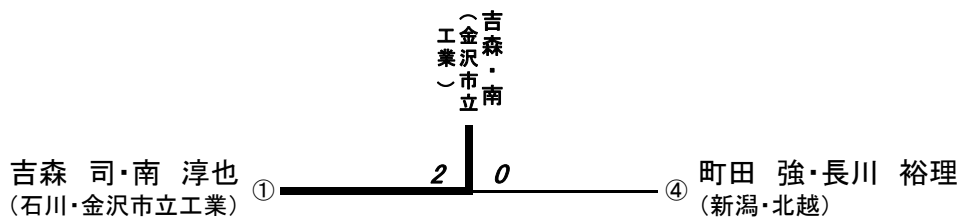

女子個人対抗戦 (GD)

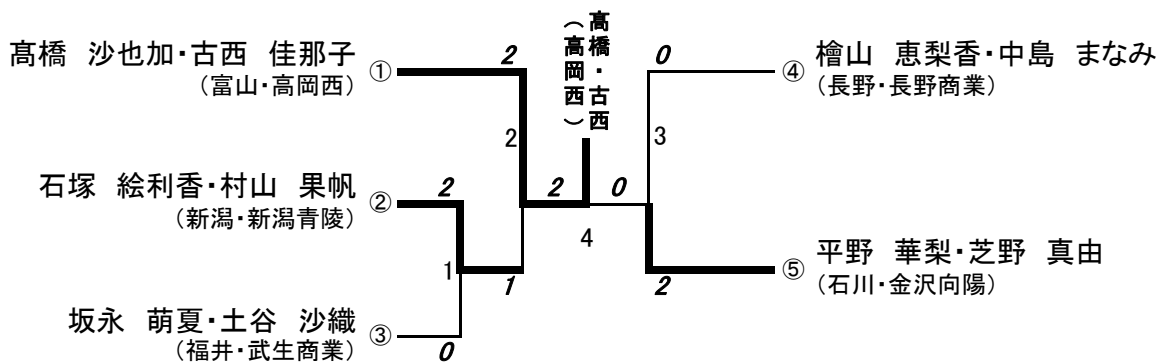

女子第2代表決定戦

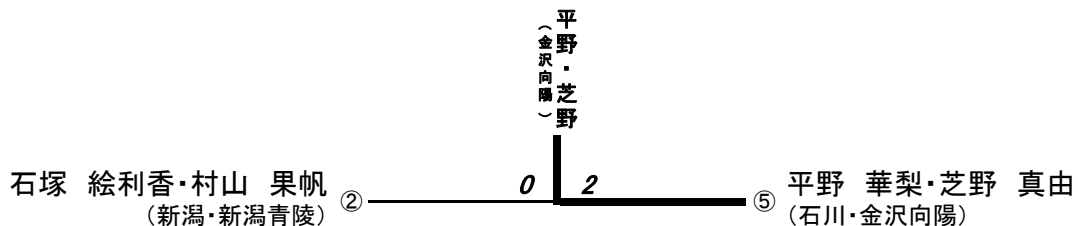

男子個人対抗戦 (BS)

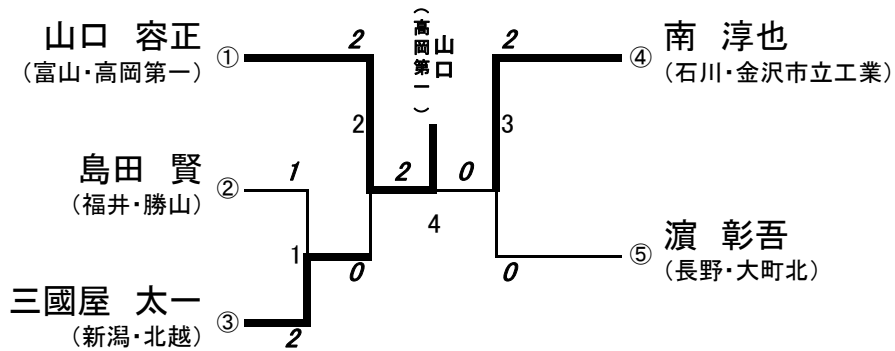

男子第2代表決定戦

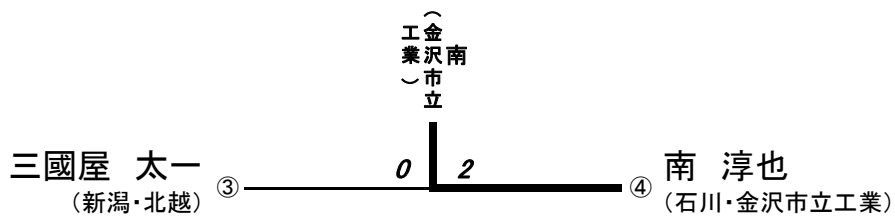

女子個人対抗戦 (GS)

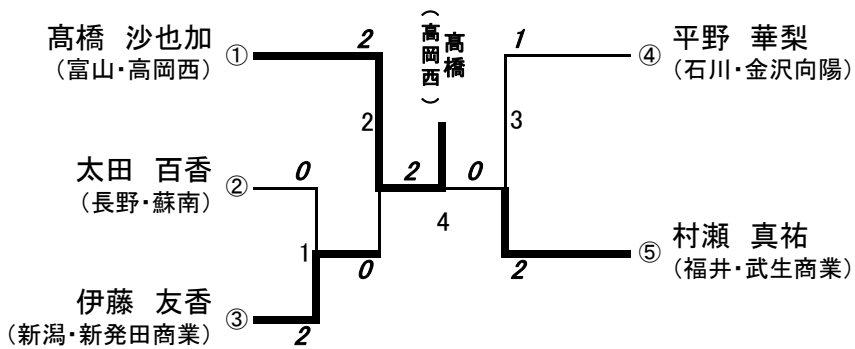

女子第2代表決定戦

